

Séparateurs pour tiroirs Dynapro

Spacers for Dynapro drawers

Instructions de montage

Mounting instructions

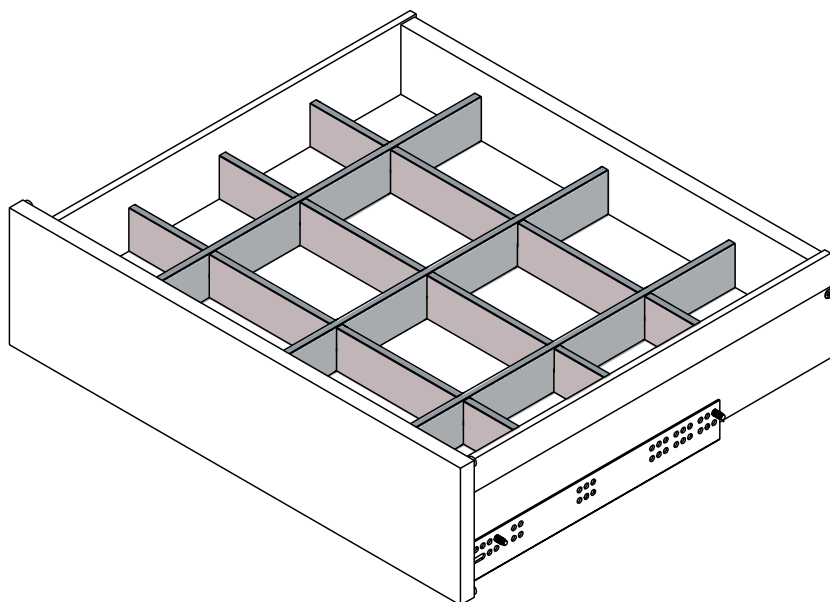
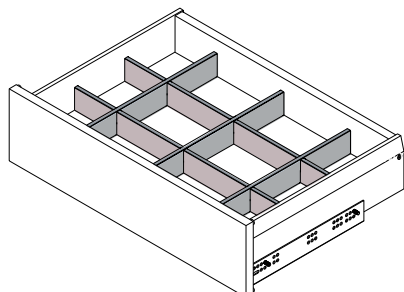
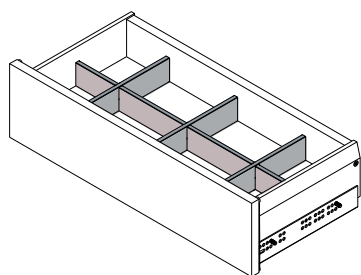

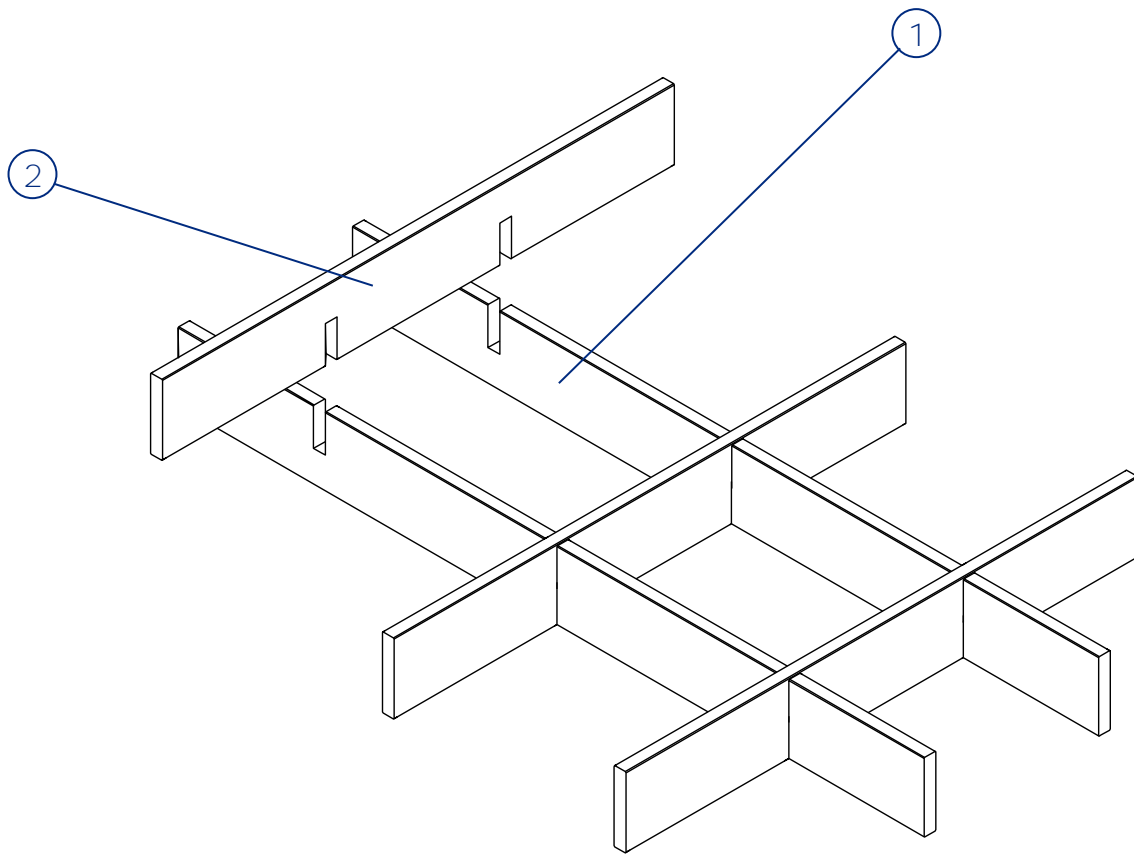

Outillage non fourni / *Not supplied tools*

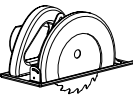
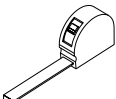
									
--	---	--	--	--	--	--	--	--	--

Quincaillerie / *Hardware*

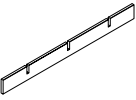
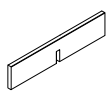
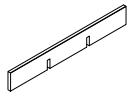
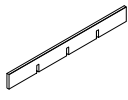
CAC_0001509	CAC_0001510	CAC_0001511	CAC_0001512						
									
1000 mm 1	241 mm 2A	371 mm 2B	471 mm 2C						

1 Découpe des séparateurs bas / *Cutting of the bottom spacers:*

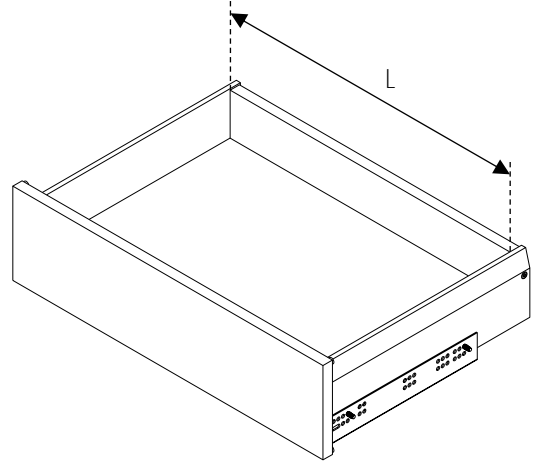
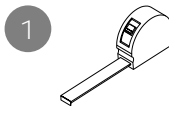
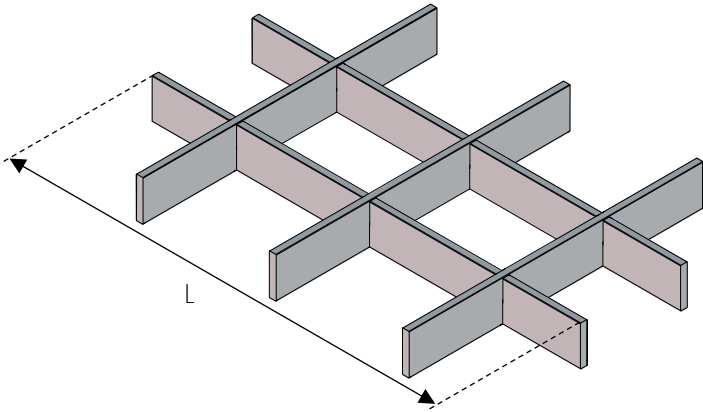

2

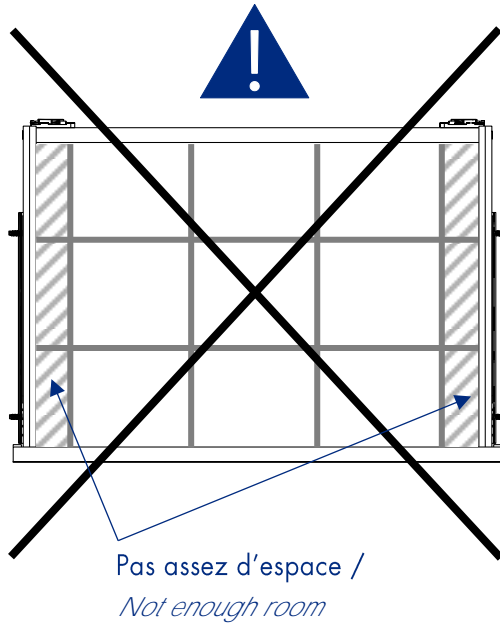

OK

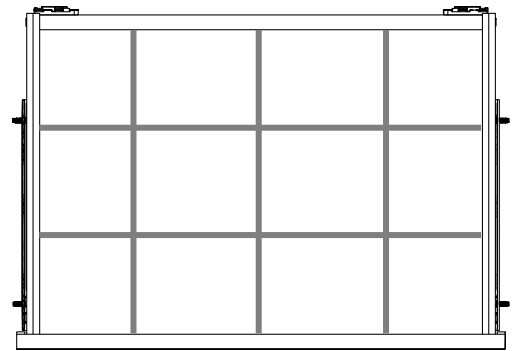

3

